

TOSHIBA CMOS Digital Integrated Circuit Silicon Monolithic

TC7MA2574FK

Low-Voltage Octal D-Type Flip-Flop with 3.6 V Tolerant Inputs and Outputs

The TC7MA2574FK is a high performance CMOS octal D-type flip-flop. Designed for use in 1.8 V, 2.5 V or 3.3 V systems, it achieves high speed operation while maintaining the CMOS low power dissipation.

It is also designed with over voltage tolerant inputs and outputs up to 3.6 V.

This 8 bit D-type flip-flop is controlled by a clock input (CK) and an output enable input (\overline{OE}). When the \overline{OE} input is high, the eight outputs are in a high impedance state.

The 26 Ω series resistor helps reducing output overshoot and undershoot without external resistor.

All inputs are equipped with protection circuits against static discharge.

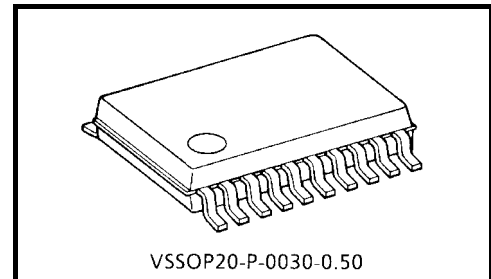

Weight: 0.03 g (typ.)

Features

- 26 Ω series resistors on outputs.
- Low voltage operation: $V_{CC} = 1.8\sim 3.6$ V
- High speed operation: $t_{pd} = 5.1$ ns (max) ($V_{CC} = 3.0\sim 3.6$ V)
 $t_{pd} = 6.2$ ns (max) ($V_{CC} = 2.3\sim 2.7$ V)
 $t_{pd} = 9.8$ ns (max) ($V_{CC} = 1.8$ V)
- 3.6 V tolerant inputs and outputs.
- Output current: $I_{OH}/I_{OL} = \pm 12$ mA (min) ($V_{CC} = 3.0$ V)
 $I_{OH}/I_{OL} = \pm 8$ mA (min) ($V_{CC} = 2.3$ V)
 $I_{OH}/I_{OL} = \pm 4$ mA (min) ($V_{CC} = 1.8$ V)
- Latch-up performance: -300 mA
- ESD performance: Machine model $\geq \pm 200$ V
Human body model $\geq \pm 2000$ V
- Package: VSSOP (US)
- Power down protection is provided on all inputs and outputs.

Pin Assignment (top view)

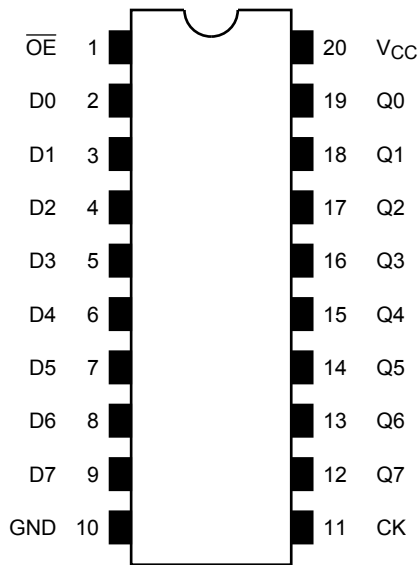

IEC Logic Level

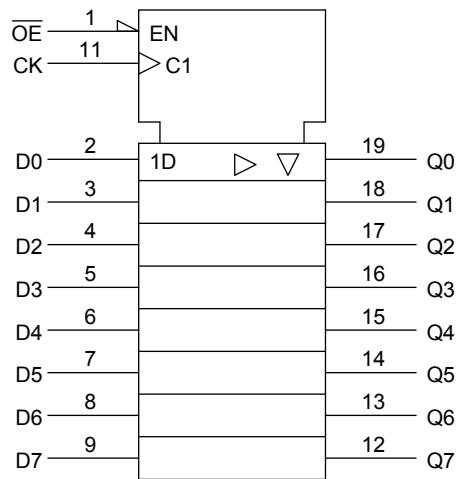

Truth Table

Inputs			Outputs
\overline{OE}	CK	D	
H	X	X	Z
L		X	Q_n
L		L	L
L		H	H

X: Don't care

Z: High impedance

Q_n : No change

System Diagram

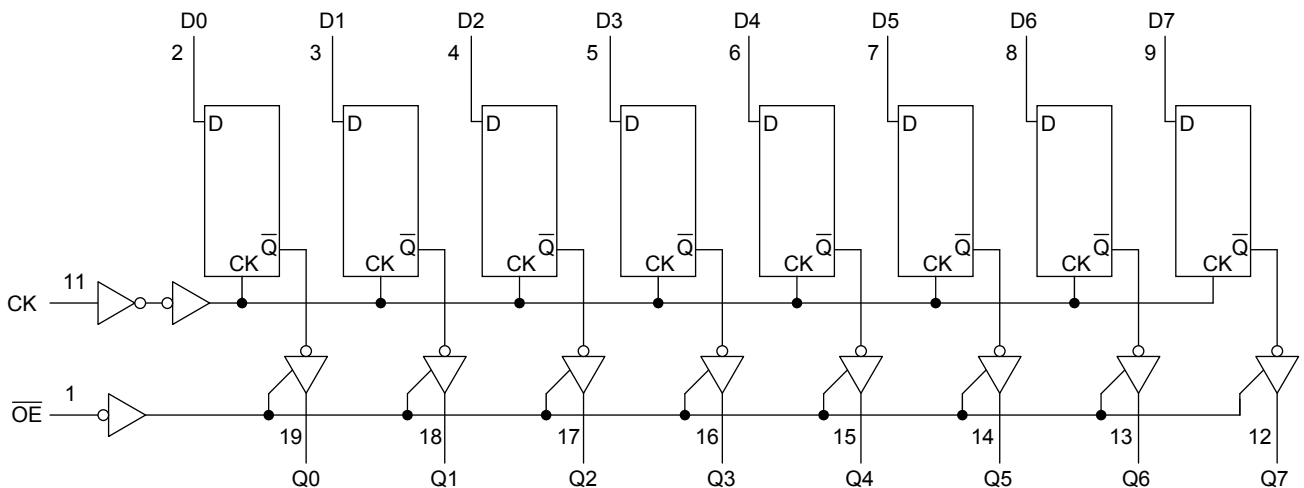

Absolute Maximum Ratings (Note 1)

Characteristics	Symbol	Rating	Unit
Power supply voltage	V_{CC}	-0.5~4.6	V
DC input voltage	V_{IN}	-0.5~4.6	V
DC output voltage	V_{OUT}	-0.5~4.6 (Note 2)	V
		-0.5~ $V_{CC} + 0.5$ (Note 3)	
Input diode current	I_{IK}	-50	mA
Output diode current	I_{OK}	±50 (Note 4)	mA
DC output current	I_{OUT}	±50	mA
Power dissipation	P_D	180	mW
DC V_{CC} /ground current	I_{CC}/I_{GND}	±100	mA
Storage temperature	T_{stg}	-65~150	°C

Note 1: Exceeding any of the absolute maximum ratings, even briefly, lead to deterioration in IC performance or even destruction.

Using continuously under heavy loads (e.g. the application of high temperature/current/voltage and the significant change in temperature, etc.) may cause this product to decrease in the reliability significantly even if the operating conditions (i.e. operating temperature/current/voltage, etc.) are within the absolute maximum ratings and the operating ranges.

Please design the appropriate reliability upon reviewing the Toshiba Semiconductor Reliability Handbook ("Handling Precautions"/"Derating Concept and Methods") and individual reliability data (i.e. reliability test report and estimated failure rate, etc).

Note 2: Off-state

Note 3: High or low state. I_{OUT} absolute maximum rating must be observed.

Note 4: $V_{OUT} < GND$, $V_{OUT} > V_{CC}$

Operating Ranges (Note 1)

Characteristics	Symbol	Rating	Unit
Supply voltage	V_{CC}	1.8~3.6	V
		1.2~3.6 (Note 2)	
Input voltage	V_{IN}	-0.3~3.6	V
Output voltage	V_{OUT}	0~3.6 (Note 3)	V
		0~ V_{CC} (Note 4)	
Output current	I_{OH}/I_{OL}	±12 (Note 5)	mA
		±8 (Note 6)	
		±4 (Note 7)	
Operating temperature	T_{opr}	-40~85	°C
Input rise and fall time	dt/dv	0~10 (Note 8)	ns/V

Note 1: The operating ranges must be maintained to ensure the normal operation of the device. Unused inputs must be tied to either V_{CC} or GND .

Note 2: Data retention only

Note 3: Off-state

Note 4: High or low state

Note 5: $V_{CC} = 3.0\sim 3.6$ V

Note 6: $V_{CC} = 2.3\sim 2.7$ V

Note 7: $V_{CC} = 1.8$ V

Note 8: $V_{IN} = 0.8\sim 2.0$ V, $V_{CC} = 3.0$ V

Electrical Characteristics

DC Characteristics (Ta = -40~85°C, 2.7 V < VCC ≤ 3.6 V)

Characteristics		Symbol	Test Condition		VCC (V)	Min	Max	Unit
Input voltage	High level	V _{IH}	—		2.7~3.6	2.0	—	V
	Low level	V _{IL}	—		2.7~3.6	—	0.8	
Output voltage	High level	V _{OH}	V _{IN} = V _{IH} or V _{IL}	I _{OH} = -100 μA	2.7~3.6	V _{CC} - 0.2	—	V
				I _{OH} = -6 mA	2.7	2.2	—	
				I _{OH} = -8 mA	3.0	2.4	—	
				I _{OH} = -12 mA	3.0	2.2	—	
	Low level	V _{OL}	V _{IN} = V _{IH} or V _{IL}	I _{OL} = 100 μA	2.7~3.6	—	0.2	
				I _{OL} = 6 mA	2.7	—	0.4	
				I _{OL} = 8 mA	3.0	—	0.55	
				I _{OL} = 12 mA	3.0	—	0.8	
Input leakage current		I _{IN}	V _{IN} = 0~3.6 V		2.7~3.6	—	±5.0	μA
3-state output off-state current		I _{OZ}	V _{IN} = V _{IH} or V _{IL} V _{OUT} = 0~3.6 V		2.7~3.6	—	±10.0	μA
Power off leakage current		I _{OFF}	V _{IN} , V _{OUT} = 0~3.6 V		0	—	10.0	μA
Quiescent supply current		I _{CC}	V _{IN} = V _{CC} or GND		2.7~3.6	—	20.0	μA
			V _{CC} ≤ (V _{IN} , V _{OUT}) ≤ 3.6 V		2.7~3.6	—	±20.0	
		ΔI _{CC}	V _{IH} = V _{CC} - 0.6 V (per input)		2.7~3.6	—	750	

DC Characteristics (Ta = -40~85°C, 2.3 V ≤ VCC ≤ 2.7 V)

Characteristics		Symbol	Test Condition		VCC (V)	Min	Max	Unit
Input voltage	High level	V _{IH}	—		2.3~2.7	1.6	—	V
	Low level	V _{IL}	—		2.3~2.7	—	0.7	
Output voltage	High level	V _{OH}	V _{IN} = V _{IH} or V _{IL}	I _{OH} = -100 μA	2.3~2.7	V _{CC} - 0.2	—	V
				I _{OH} = -4 mA	2.3	2.0	—	
				I _{OH} = -6 mA	2.3	1.8	—	
				I _{OH} = -8 mA	2.3	1.7	—	
	Low level	V _{OL}	V _{IN} = V _{IH} or V _{IL}	I _{OL} = 100 μA	2.3~2.7	—	0.2	
				I _{OL} = 6 mA	2.3	—	0.4	
				I _{OL} = 8 mA	2.3	—	0.6	
Input leakage current		I _{IN}	V _{IN} = 0~3.6 V		2.3~2.7	—	±5.0	μA
3-state output off-state current		I _{OZ}	V _{IN} = V _{IH} or V _{IL} V _{OUT} = 0~3.6 V		2.3~2.7	—	±10.0	μA
Power off leakage current		I _{OFF}	V _{IN} , V _{OUT} = 0~3.6 V		0	—	10.0	μA
Quiescent supply current		I _{CC}	V _{IN} = V _{CC} or GND		2.3~2.7	—	20.0	μA
			V _{CC} ≤ (V _{IN} , V _{OUT}) ≤ 3.6 V		2.3~2.7	—	±20.0	

DC Characteristics (Ta = -40~85°C, 1.8 V ≤ VCC < 2.3 V)

Characteristics		Symbol	Test Condition		VCC (V)	Min	Max	Unit
Input voltage	High level	V _{IH}	—		1.8~2.3	0.7 × V _{CC}	—	V
	Low level	V _{IL}	—		1.8~2.3	—	0.2 × V _{CC}	
Output voltage	High level	V _{OH}	V _{IN} = V _{IH} or V _{IL}	I _{OH} = -100 μA	1.8	V _{CC} - 0.2	—	V
				I _{OH} = -4 mA	1.8	1.4	—	
	Low level	V _{OL}	V _{IN} = V _{IH} or V _{IL}	I _{OL} = 100 μA	1.8	—	0.2	
				I _{OL} = 4 mA	1.8	—	0.3	
Input leakage current		I _{IN}	V _{IN} = 0~3.6 V		1.8	—	±5.0	μA
3-state output off-state current		I _{OZ}	V _{IN} = V _{IH} or V _{IL} V _{OUT} = 0~3.6 V		1.8	—	±10.0	μA
Power off leakage current		I _{OFF}	V _{IN} , V _{OUT} = 0~3.6 V		0	—	10.0	μA
Quiescent supply current		I _{CC}	V _{IN} = V _{CC} or GND		1.8	—	20.0	μA
			V _{CC} ≤ (V _{IN} , V _{OUT}) ≤ 3.6 V		1.8	—	±20.0	

AC Characteristics (Ta = -40~85°C, Input: tr = tf = 2.0 ns, CL = 30 pF, RL = 500 Ω)

Characteristics	Symbol	Test Condition	VCC (V)	Min	Max	Unit
Maximum clock frequency	f _{max}	Figure 1, Figure 2	1.8	100	—	MHz
			2.5 ± 0.2	200	—	
			3.3 ± 0.3	250	—	
Propagation delay time (CK-Q)	t _{pLH} t _{pHL}	Figure 1, Figure 2	1.8	1.5	9.8	ns
			2.5 ± 0.2	0.8	6.2	
			3.3 ± 0.3	0.6	5.1	
3-state output enable time	t _{pZL} t _{pZH}	Figure 1, Figure 3	1.8	1.5	9.8	ns
			2.5 ± 0.2	0.8	6.5	
			3.3 ± 0.3	0.6	5.0	
3-state output disable time	t _{pLZ} t _{pHZ}	Figure 1, Figure 3	1.8	1.5	7.7	ns
			2.5 ± 0.2	0.8	4.3	
			3.3 ± 0.3	0.6	3.9	
Minimum pulse width (CK)	t _w (H) t _w (L)	Figure 1, Figure 2	1.8	4.0	—	ns
			2.5 ± 0.2	1.5	—	
			3.3 ± 0.3	1.5	—	
Minimum set-up time	t _s	Figure 1, Figure 2	1.8	2.5	—	ns
			2.5 ± 0.2	1.5	—	
			3.3 ± 0.3	1.5	—	
Minimum hold time	t _h	Figure 1, Figure 2	1.8	1.0	—	ns
			2.5 ± 0.2	1.0	—	
			3.3 ± 0.3	1.0	—	
Output to output skew	t _{osLH} t _{osHL}	(Note)	1.8	—	0.5	ns
			2.5 ± 0.2	—	0.5	
			3.3 ± 0.3	—	0.5	

For C_L = 50 pF, add approximately 300 ps to the AC maximum specification.

Note: This parameter is guaranteed by design.

$$(t_{osLH} = |t_{pLHm} - t_{pLHn}|, t_{osHL} = |t_{pHLm} - t_{pHLn}|)$$

Dynamic Switching Characteristics (Ta = 25°C, Input: tr = tf = 2.0 ns, CL = 30 pF)

Characteristics	Symbol	Test Condition	VCC (V)	Typ.	Unit
Quiet output maximum dynamic VOL	VOLP	VIH = 1.8 V, VIL = 0 V (Note)	1.8	0.15	V
		VIH = 2.5 V, VIL = 0 V (Note)	2.5	0.25	
		VIH = 3.3 V, VIL = 0 V (Note)	3.3	0.35	
Quiet output minimum dynamic VOL	VOLV	VIH = 1.8 V, VIL = 0 V (Note)	1.8	-0.15	V
		VIH = 2.5 V, VIL = 0 V (Note)	2.5	-0.25	
		VIH = 3.3 V, VIL = 0 V (Note)	3.3	-0.35	
Quiet output minimum dynamic VOH	VOHV	VIH = 1.8 V, VIL = 0 V (Note)	1.8	1.55	V
		VIH = 2.5 V, VIL = 0 V (Note)	2.5	2.05	
		VIH = 3.3 V, VIL = 0 V (Note)	3.3	2.65	

Note: This parameter is guaranteed by design.

Capacitive Characteristics (Ta = 25°C)

Characteristics	Symbol	Test Condition	VCC (V)	Typ.	Unit
Input capacitance	CIN	—	1.8, 2.5, 3.3	6	pF
Output capacitance	COUT	—	1.8, 2.5, 3.3	7	pF
Power dissipation capacitance	CPD	fIN = 10 MHz (Note)	1.8, 2.5, 3.3	20	pF

Note: CPD is defined as the value of the internal equivalent capacitance which is calculated from the operating current consumption without load.

Average operating current can be obtained by the equation:

$$I_{CC (opr)} = C_{PD} \cdot V_{CC} \cdot f_{IN} + I_{CC}/8 \text{ (per bit)}$$

AC Test Circuit

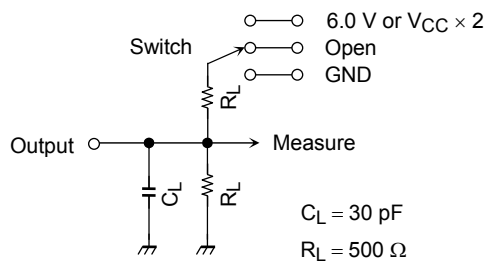

Parameter	Switch
t_{pLH}, t_{pHL}	Open
t_{pLZ}, t_{pZL}	6.0 V @ $V_{CC} = 3.3 \pm 0.3 \text{ V}$ $V_{CC} \times 2$ @ $V_{CC} = 2.5 \pm 0.2 \text{ V}$ @ $V_{CC} = 1.8 \text{ V}$
t_{pHZ}, t_{pZH}	GND

Figure 1

AC Waveform

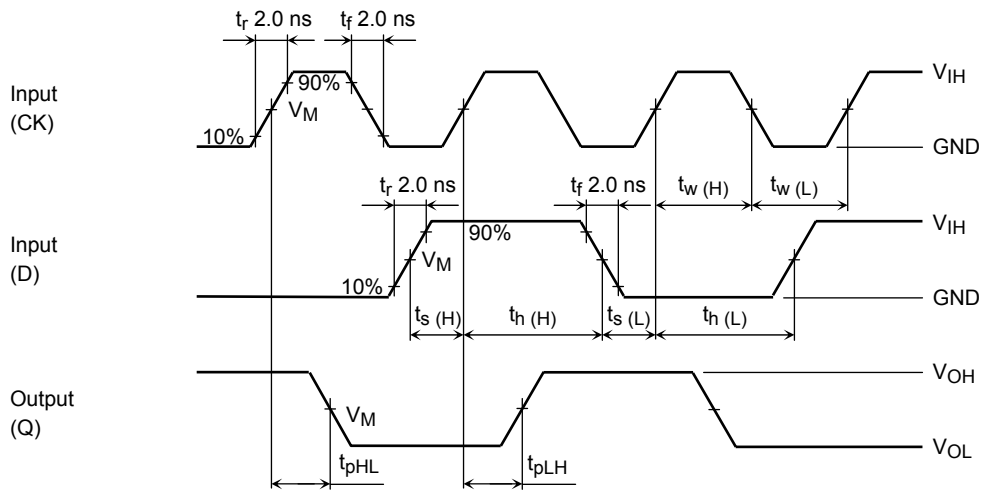

Figure 2 $t_{pLH}, t_{pHL}, t_w, t_s, t_h$

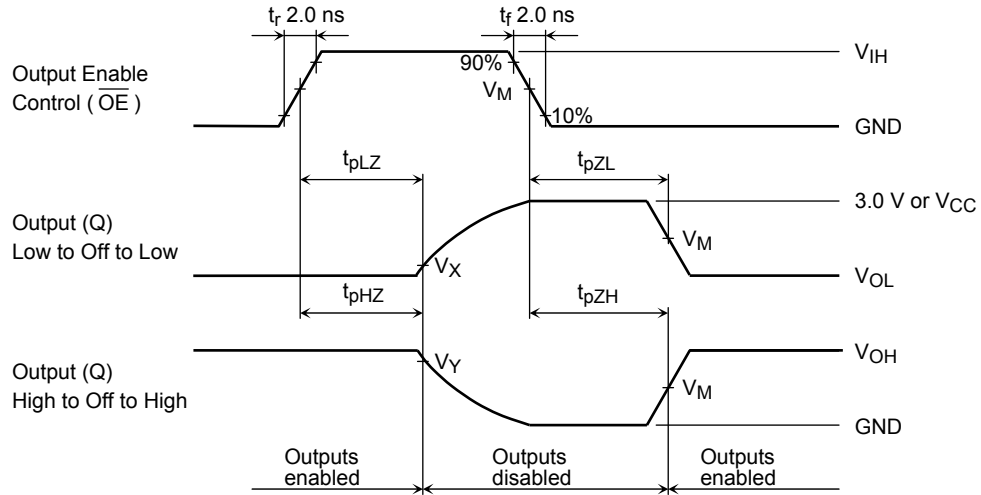

Figure 3 t_{pLZ} , t_{pHZ} , t_{pZL} , t_{pZH}

Symbol	V_{CC}		
	$3.3 \pm 0.3 \text{ V}$	$2.5 \pm 0.2 \text{ V}$	1.8 V
V_{IH}	2.7 V	V_{CC}	V_{CC}
V_M	1.5 V	$V_{CC}/2$	$V_{CC}/2$
V_x	$V_{OL} + 0.3 \text{ V}$	$V_{OL} + 0.15 \text{ V}$	$V_{OL} + 0.15 \text{ V}$
V_y	$V_{OH} - 0.3 \text{ V}$	$V_{OH} - 0.15 \text{ V}$	$V_{OH} - 0.15 \text{ V}$

Package Dimensions

VSSOP20-P-0030-0.50

Unit : mm

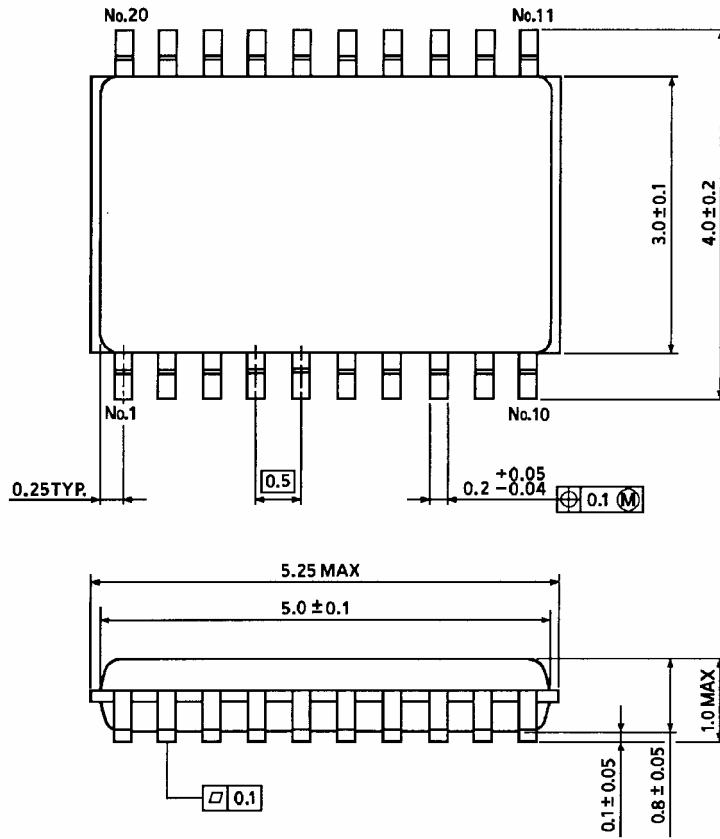

Weight: 0.03 g (typ.)

RESTRICTIONS ON PRODUCT USE

20070701-EN GENERAL

- The information contained herein is subject to change without notice.
- TOSHIBA is continually working to improve the quality and reliability of its products. Nevertheless, semiconductor devices in general can malfunction or fail due to their inherent electrical sensitivity and vulnerability to physical stress. It is the responsibility of the buyer, when utilizing TOSHIBA products, to comply with the standards of safety in making a safe design for the entire system, and to avoid situations in which a malfunction or failure of such TOSHIBA products could cause loss of human life, bodily injury or damage to property.
In developing your designs, please ensure that TOSHIBA products are used within specified operating ranges as set forth in the most recent TOSHIBA products specifications. Also, please keep in mind the precautions and conditions set forth in the "Handling Guide for Semiconductor Devices," or "TOSHIBA Semiconductor Reliability Handbook" etc.
- The TOSHIBA products listed in this document are intended for usage in general electronics applications (computer, personal equipment, office equipment, measuring equipment, industrial robotics, domestic appliances, etc.). These TOSHIBA products are neither intended nor warranted for usage in equipment that requires extraordinarily high quality and/or reliability or a malfunction or failure of which may cause loss of human life or bodily injury ("Unintended Usage"). Unintended Usage include atomic energy control instruments, airplane or spaceship instruments, transportation instruments, traffic signal instruments, combustion control instruments, medical instruments, all types of safety devices, etc.. Unintended Usage of TOSHIBA products listed in this document shall be made at the customer's own risk.
- The products described in this document shall not be used or embedded to any downstream products of which manufacture, use and/or sale are prohibited under any applicable laws and regulations.
- The information contained herein is presented only as a guide for the applications of our products. No responsibility is assumed by TOSHIBA for any infringements of patents or other rights of the third parties which may result from its use. No license is granted by implication or otherwise under any patents or other rights of TOSHIBA or the third parties.
- Please contact your sales representative for product-by-product details in this document regarding RoHS compatibility. Please use these products in this document in compliance with all applicable laws and regulations that regulate the inclusion or use of controlled substances. Toshiba assumes no liability for damage or losses occurring as a result of noncompliance with applicable laws and regulations.